

FLEX

PERSONAL STORAGE



Lundqvist™
INREDNINGAR



FLEX

A storage system with incredible flexibility designed in collaboration with Alpen Office. The system is based on two depths, two widths, and four heights. Choose materials and colours that blend seamlessly into your environment or create a bold statement in the interior design.

Add locks, mail inserts, seating modules, side tables, lighting, and power outlets—or why not a charging pad for your phone—and create a complete unit with all the features today's flexible workplaces demand! Add FLEX!

1.

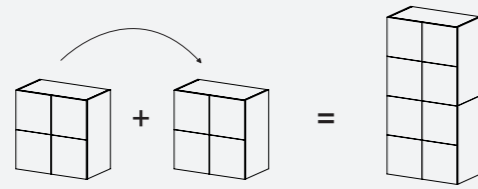

Select modules...

2.

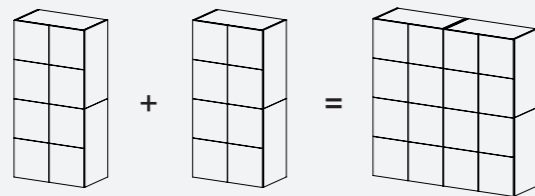

...combine on width and height...

3.

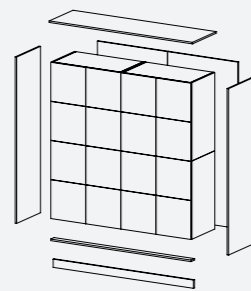

...choose materials for cover panels and doors...

4.

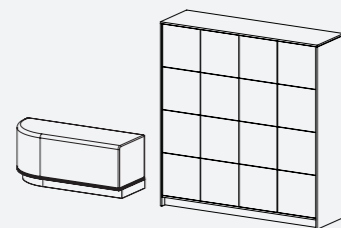

...select accessories.

*You can also choose locks, doors, interiors, and more unique module solutions.

Modules, width 800 mm, depth 470/570 mm

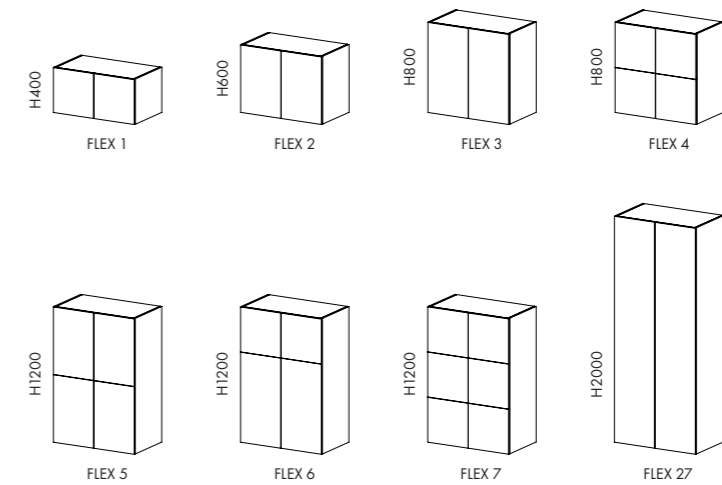

Modules, width 1200 mm, depth 470/570 mm

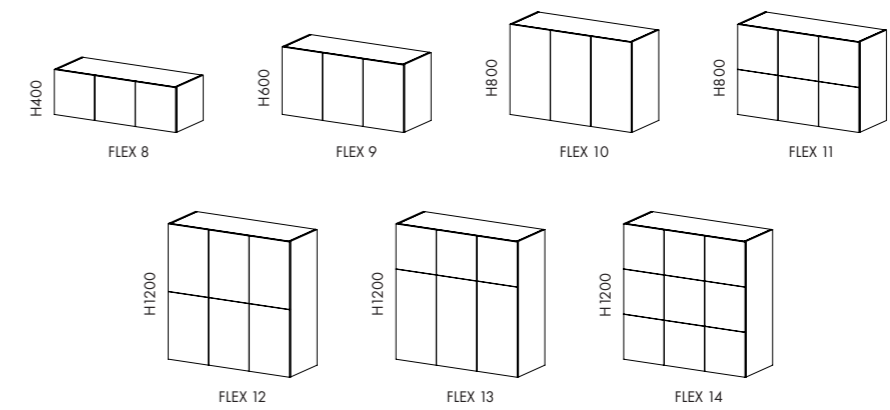

Open modules, width 400/800/1200 mm, depth 470/570 mm

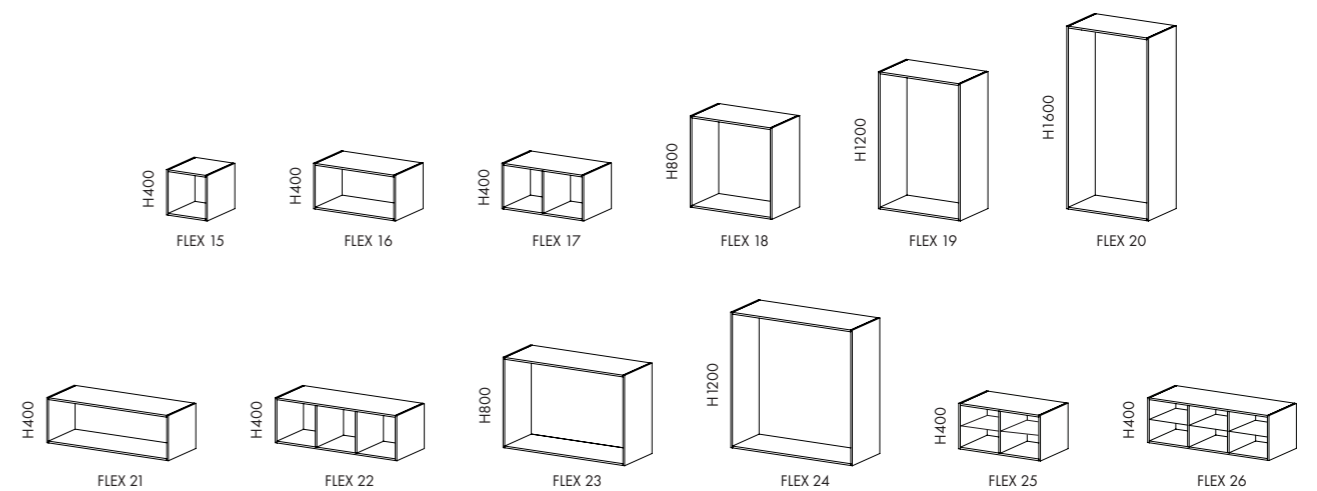

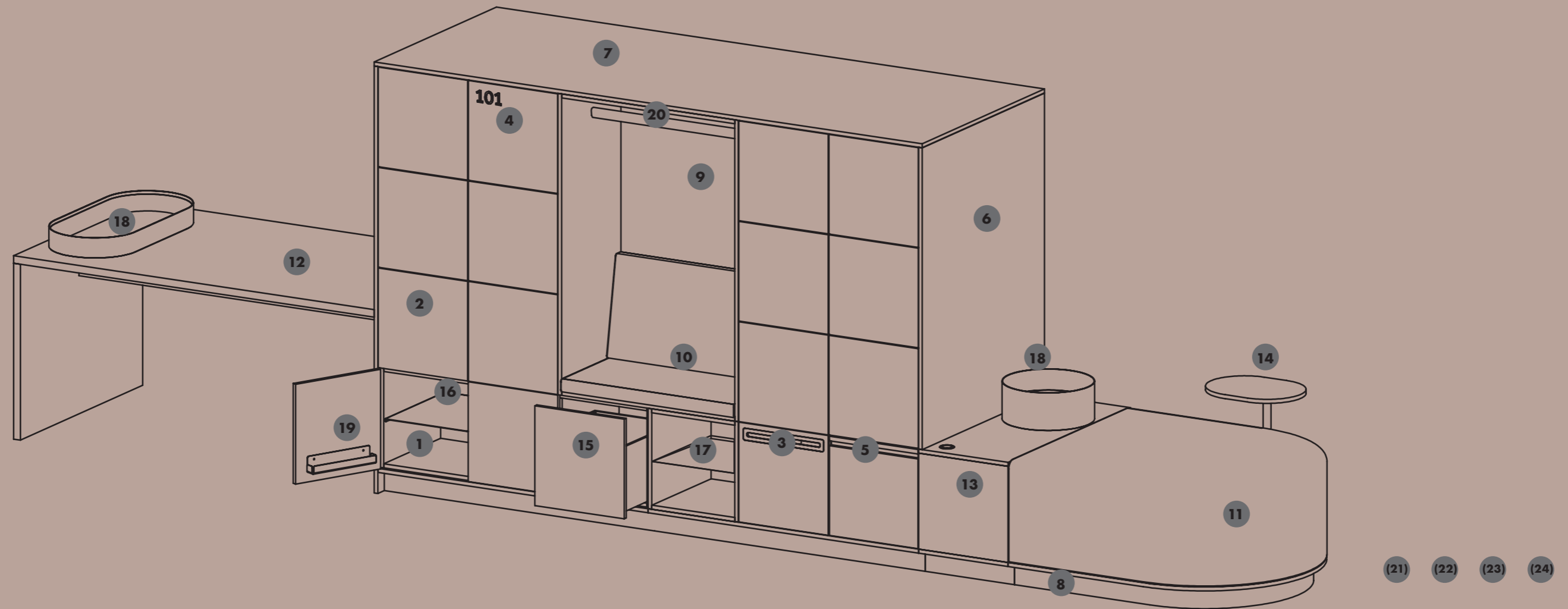

1. MODULES Made in 16 mm directly laminated particleboard, colour white, 3 mm back. Doors are included for each module.

2. DOORS Right-handed. The door is made in 16 mm chipboard. Available in optional colour, laminate and veneer in white-pigmented ash, birch and oak.

3. MAIL DEPOSITS Same design as door. Protective lining is powder coated.

4. NUMBERING OF DOORS Cut-out decal in vinyl plastic. Standard colors are black or white. Other colours is possible.

5. HANDLES Available with numbering. In 1.5 mm powder coated sheet metal.

6-8. COVER- & CAPPING PANELS / SKIRTING BOARDS / TRIMS Made in 16 mm particleboard, skirting board height 100 alt. 200 mm incl. trim at the top of the skirting board. Available in any colour, as well as in laminate and veneer in white-pigmented ash, birch and oak, alt. coloured MDF. All parts are adapted to the order's length and height. Maximum length of seamless cover boards, capping boards, skirtingboards, and trims is 2400 mm.

9. OPEN MODULES Made in 16 mm particleboard. Available in any colour, coloured MDF, laminate and veneer in white-pigmented ash, birch and oak and coloured MDF.

10. SOFAS Upholstered seat and back.

11. POUFS Upholstered pouf for stand-alone modules or modules against a wall. Skirting board and trims is same as cover and capping panels.

12. PROJECT TABLES Made in 30 mm particleboard. Available in laminate and veneer. Length and height are adapted to the order.

13. END TABLES Made in 16 mm particleboard, placed between pouf and cabinet. Available in any colour, laminate and veneer in white-pigmented ash, birch and oak.

14. ADDITIONAL TABLES The top is made from 16 mm particleboard, with a column of 30 mm diameter in 1.5 mm sheet metal. Available in laminate and veneer in white-pigmented ash, birch and oak. The base is powder-coated.

15. DRAWERS The drawer front is made from 16 mm particleboard. Available in heights of 200/400 mm, width 400 mm. Available in any color, laminate, and veneer finishes in white-pigmented ash, birch and oak.

16. SHELVES 16 mm direct-laminated particleboard or 1.5 mm powder-coated sheet metal in RAL 9010, Pure White (standard).

17. EXTENDABLE SHOE RACK FOR OPEN MODULE
Made from 1.5 mm sheet metal, powder-coated.

18. DISPLAY CONTAINER
Available in 2 sizes, made from 2.0 mm sheet metal, powder-coated. With protection tray bottom or insert in wood.

19. SHEET METAL SHELVES Made from 1.5 mm sheet metal, powder-coated as standard in RAL 9010, Pure White.

20. WARDROBE RAILS Accessory for open module, available in lengths of 800 mm or 1200 mm. Powder-coated.

(21.) BACKS 3 mm white fiberboard as standard when placed against a wall. For freestanding units, an additional back panel in 16 mm is available. Available in veneer, laminate, coloured MDF, lacquered, fabric, and bulletin board.

(22.) ACCESSORIES Accessories such as various lock types, hooks, electrical options, nameplates, mirrors, and lighting can be found on page 14.

(23.) WARDROBES Wardrobe module is available.

(24.) PLANTING BOXES The plant boxes are available in white/light grey laminate, high-pressure laminate, veneer, or lacquered finishes. Plastic protection trays included. Functions as an outer casing for planting containers.



FLEX INFO

Flex is a modular system designed for storage, work, and interaction needs of today and tomorrow. The core idea is simple – a flexible system built around a few basic components that allow countless variations and can serve as more than just storage. Choose a set of base modules and then combine them freely in height and width.

Take your storage to a new level by complementing your Flex with accessories such as side tables, seating poufs, and project tables for a comfortable and inviting environment.

FLEX MEASUREMENTS

	Thickness (mm)	Height (mm)
Cabinets	16	-
Cover panels	16	-
Capping panels	16	-
Doors	16	-
Skirting boards & trims	16	100
Back (Standard)	3	-
Textile back	16	-
Project table	30	930/1100
Seating	50	-
Display containers	2	80/150

Internal dimensions cabinet

Compartment size	Depth (mm)	Width (mm)	Height (mm)
400x400mm	438/538	376*	376**
400x600mm	438/538	376*	576
400x800mm	438/538	376*	776

* The middle compartment in the 1200 module has a width of 384 mm. The doors are the same size.

** The middle compartment in the 1200 module has a height of 384 mm. The doors are the same size.

Open modules	Depth (mm)	Width (mm)	Height (mm)
FLEX 15	455/555	368	368
FLEX 16	455/555	768	368
FLEX 17	455/555	768	368
FLEX 18	455/555	768	768
FLEX 19	455/555	768	1168
FLEX 20	455/555	768	1568
FLEX 21	455/555	1168	368
FLEX 22	455/555	1168	368
FLEX 23	455/555	1168	768

Total height/Setup: Selected module height + 116 mm (100 mm base) + 16 mm capping panel.

Total width/Setup: Selected module width + 32 mm (16 + 16 mm).

Are you missing material options?
Do you need a different size to fit your space?
We can handle most requests—contact us!

FLEX MODULES WIDTH 800 MM

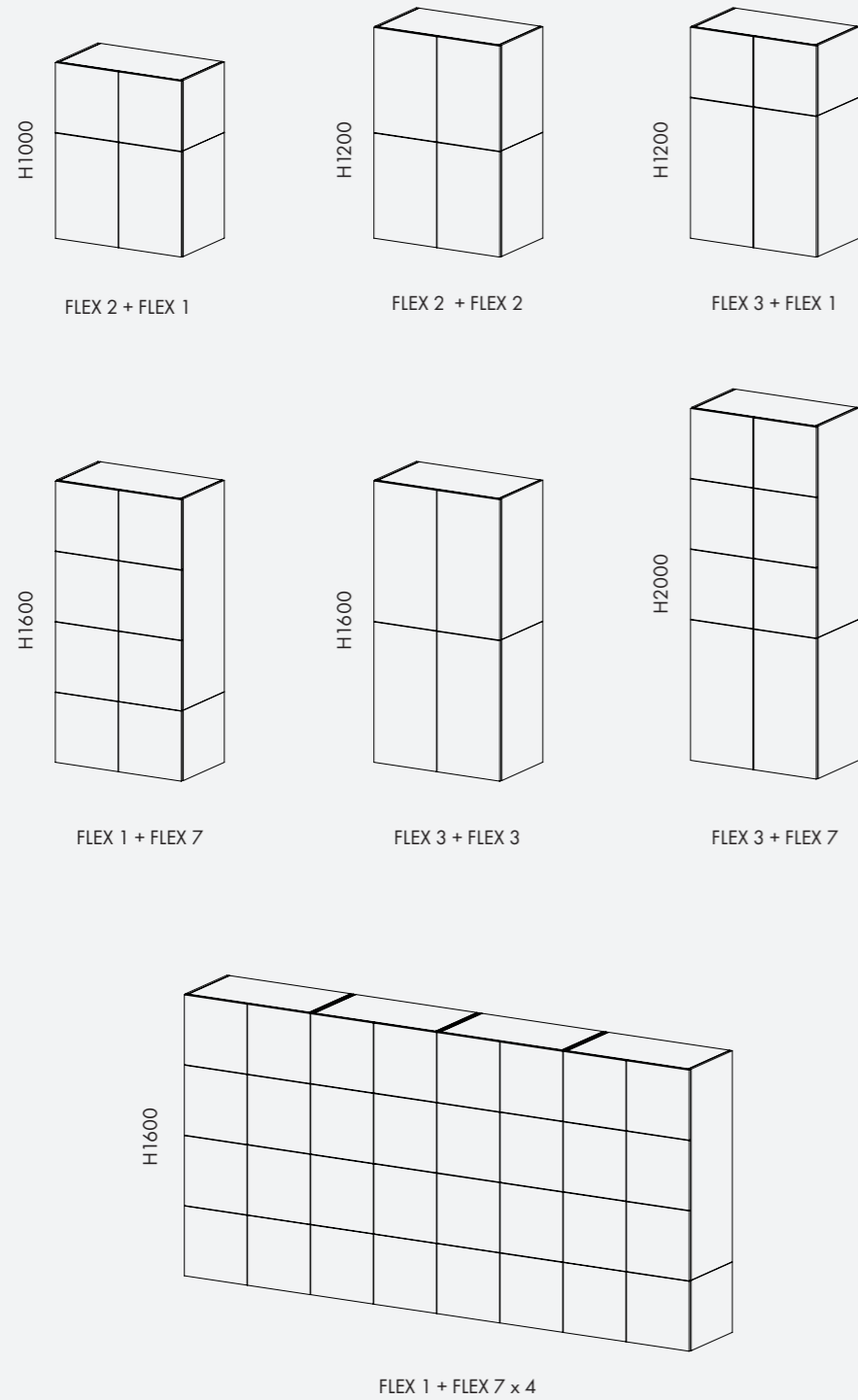

FLEX MODULES WIDTH 800 MM

A plain door is included with all base modules. Below are the variations available with 2 cabinets in width. Combine them freely to create the perfect storage unit to meet your needs.

A cabinet measuring 400x400 mm works perfectly for storing binders, a laptop, and perhaps a handbag. A 600x400 mm cabinet fits a cabin suitcase or can be equipped with extra shelves for storing personal belongings, a bag, and work tools.

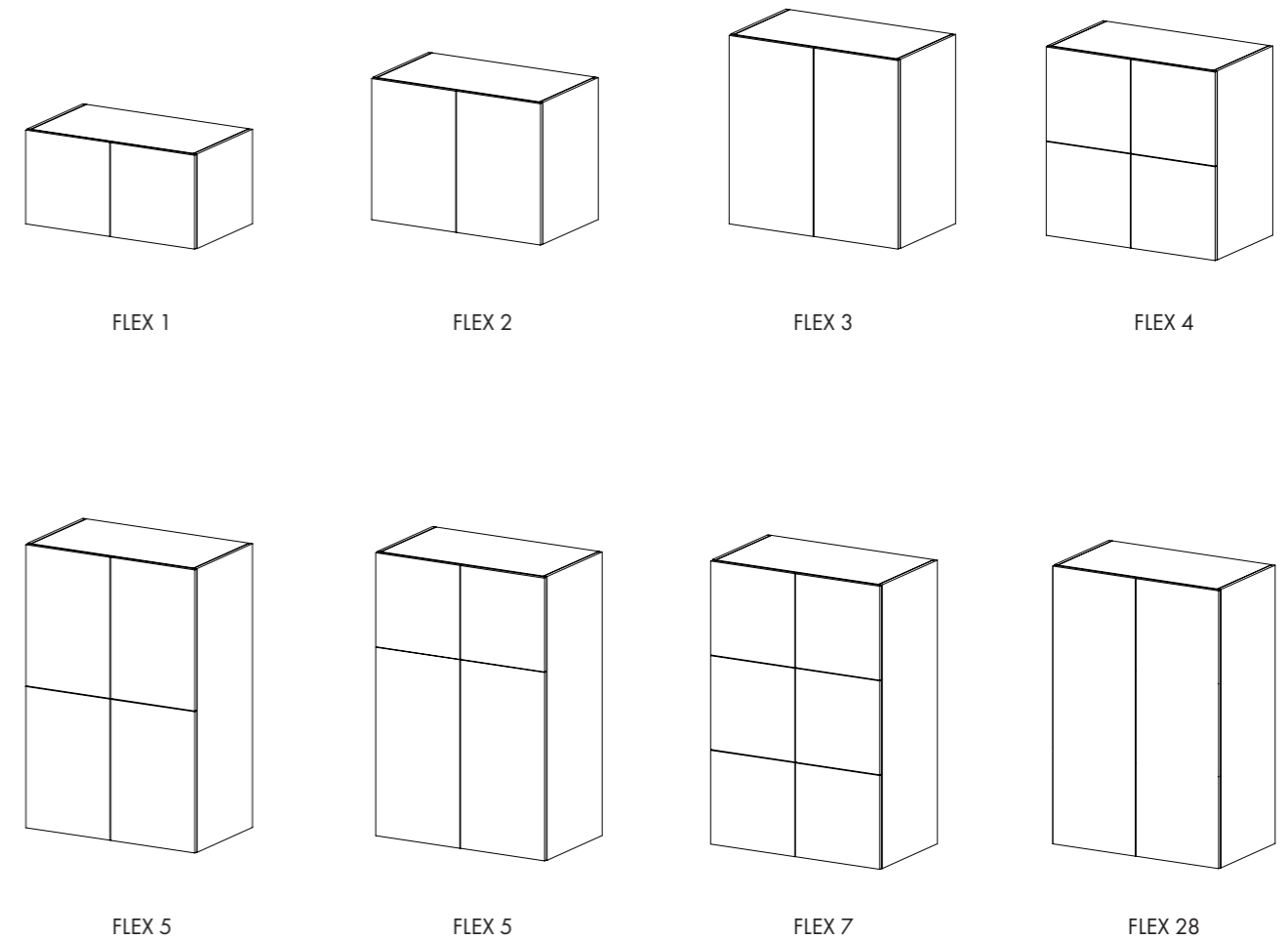

	Height (mm)	Depth (mm)	Art. no.
FLEX 1	400	470/570	F1010-/F2010-
FLEX 2	600	470/570	F1020-/F2020-
FLEX 3	600	470/570	F1030-/F2030-
FLEX 4	600	470/570	F1040-/F2040-
FLEX 5	1200	470/570	F1050-/F2050-
FLEX 6	1200	470/570	F1060-/F2060-
FLEX 7	1200	470/570	F1070-/F2070-
FLEX 28	1200	470/570	F1080-/F2080-

FLEX MODULES WIDTH 1200 MM

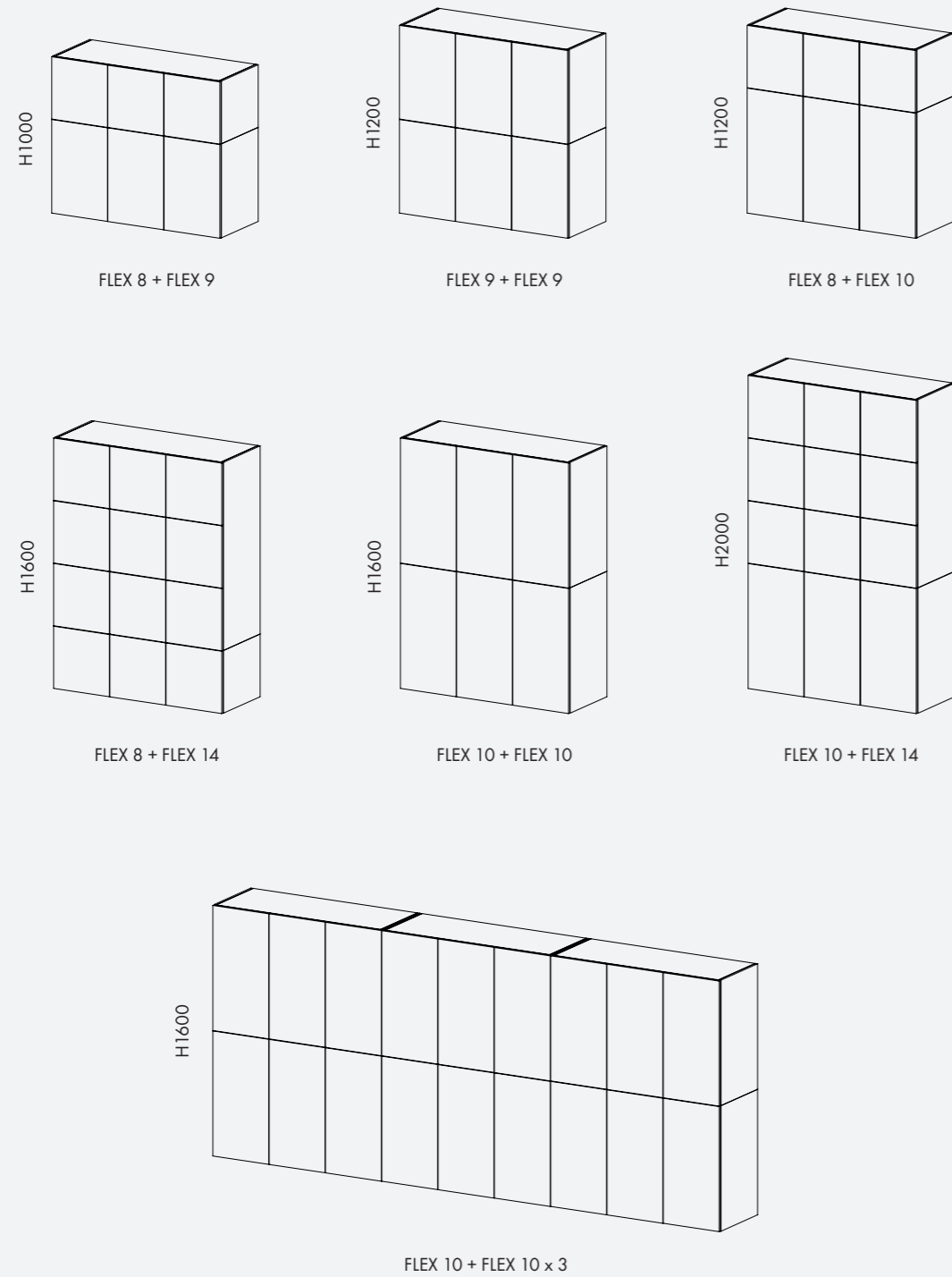

FLEX MODULES WIDTH 1200 MM

A plain door is included with all base modules. Below are the variations available with 2 cabinets in width. Combine them freely to create the perfect storage unit to meet your needs.

A cabinet measuring 400x400 mm works perfectly for storing binders, a laptop, and perhaps a handbag. A 600x400 mm cabinet fits a cabin suitcase or can be equipped with extra shelves for storing personal belongings, a bag, and work tools.

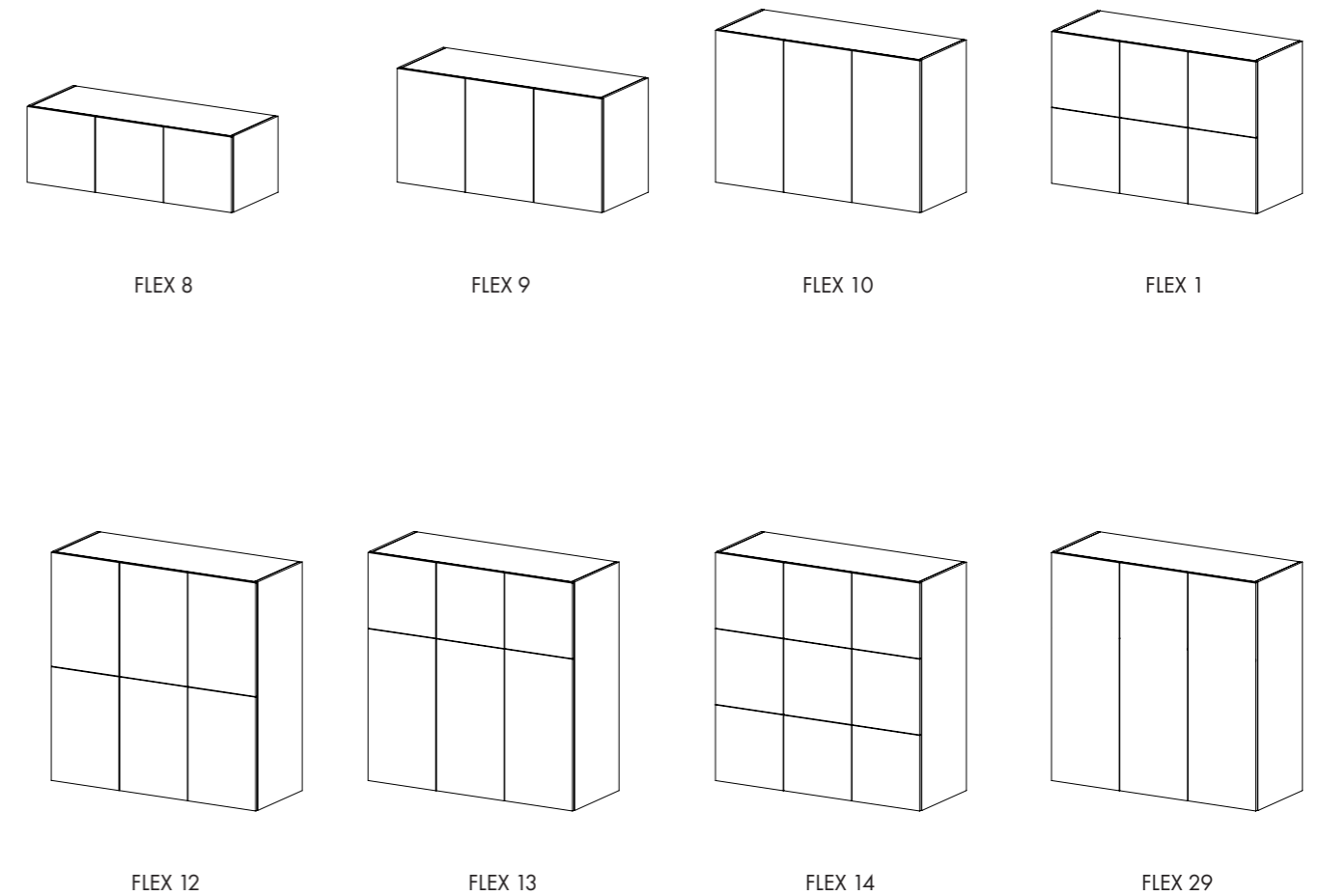

	Height (mm)	Depth (mm)	Art. no.
FLEX 8	400	470/570	F3010-/F4010-
FLEX 9	600	470/570	F3020-/F4020-
FLEX 10	600	470/570	F3030-/F4030-
FLEX 11	600	470/570	F3040-/F4040-
FLEX 12	1200	470/570	F3050-/F4050-
FLEX 13	1200	470/570	F3060-/F4060-
FLEX 14	1200	470/570	F3070-/F4070-
FLEX 29	1200	470/570	F3080-/F4080-

FLEX MODULES WIDTH 400, 800, 1200 MM

Full-width modules with paired doors
without intermediate end panels

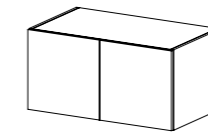

FLEX 30

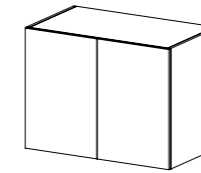

FLEX 31

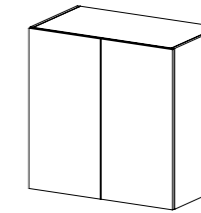

FLEX 32

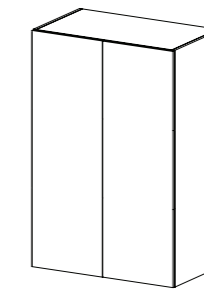

FLEX 33

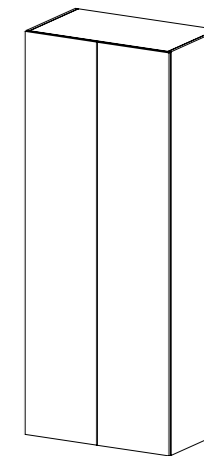

FLEX 27

Modules with one door

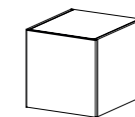

FLEX 34

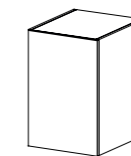

FLEX 35

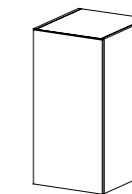

FLEX 36

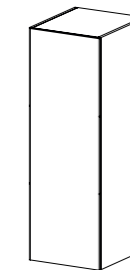

FLEX 37

Drawer modules width 800

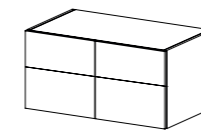

FLEX 50

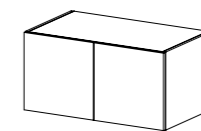

FLEX 51

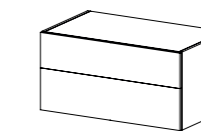

FLEX 52

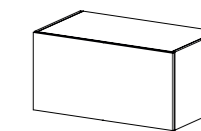

FLEX 53

Drawer modules width 1200

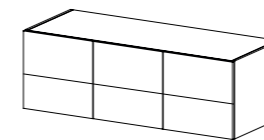

FLEX 54

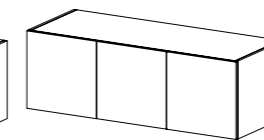

FLEX 55

	Width (mm)	Height (mm)	Depth (mm)	Art. no.
FLEX 30	800	400	470/570	F1015-/F2015-
FLEX 31	800	600	470/570	F1025-/F2025-
FLEX 32	800	800	470/570	F1035-/F2035-
FLEX 33	800	1200	470/570	F1085-/F2085-
FLEX 27	800	2000	470/570	F8055-/F8056-
FLEX 34	400	400	470/570	F0010-/F0510-
FLEX 35	400	600	470/570	F0020-/F0520-
FLEX 36	400	600	470/570	F0030-/F0530-
FLEX 37	400	1200	470/570	F0080-/F0580-
FLEX 50	800	400	470/570	F1016-/F2016-
FLEX 51	800	400	470/570	F1017-/F2017-
FLEX 52	800	400	470/570	F1018-/F2018-
FLEX 53	800	400	470/570	F1019-/F2019-
FLEX 54	1200	400	470/570	F3016-/F4016-
FLEX 55	1200	400	470/570	F3017-/F4017-

FLEX OPEN MODULES

Open modules are used when you want storage without covering doors, these modules can be available in the same material selection as the doors and cover/capping panels. Combine freely with different accessories such as lighting, mirrors, sofas, clothes rail and different types of electrical outlets.

Open modules have a greater depth to line with the fronts of the other modules.

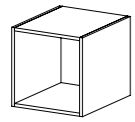

FLEX 15

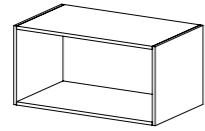

FLEX 16

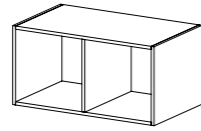

FLEX 17

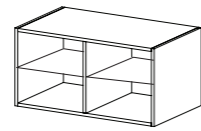

FLEX 25

Shoe rack incl. 3 metal shelves and rubber mat at the bottom

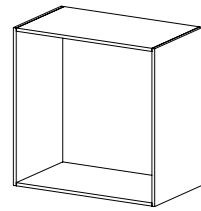

FLEX 18

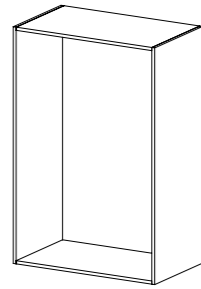

FLEX 19

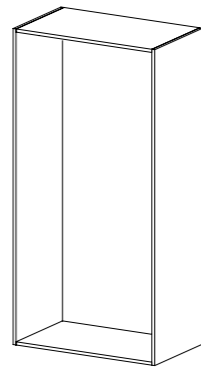

FLEX 20

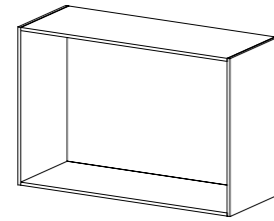

FLEX 23

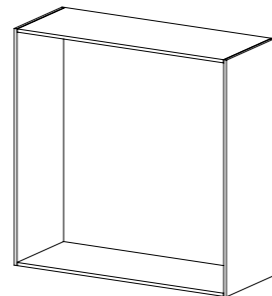

FLEX 24

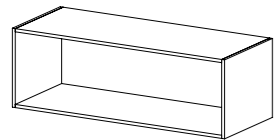

FLEX 21

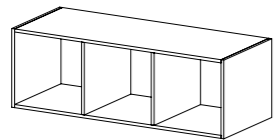

FLEX 22

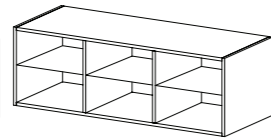

FLEX 26

Shoe rack incl. 3 metal shelves and rubber mat at the bottom

	Width (mm)	Height (mm)	Depth (mm)	Art. no.
FLEX 15	400	400	470/570	F5010-/F6010-
FLEX 16	800	400	470/570	F5011-/F6011-
FLEX 17	800	400	470/570	F5012-/F6012-
FLEX 25	800	400	470/570	F5020-/F6020-
FLEX 18	800	800	470/570	F5013-/F6013-
FLEX 19	800	1200	470/570	F5014-/F6014-
FLEX 20	800	1600	470/570	F5015-/F6015-
FLEX 23	1200	800	470/570	F5018-/F6018-
FLEX 24	1200	1200	470/570	F5019-/F6019-
FLEX 21	1200	400	470/570	F5016-/F6016-
FLEX 22	1200	400	470/570	F5017-/F6017-
FLEX 26	1200	400	470/570	F5021-/F6021-





FLEX COVER PANELS

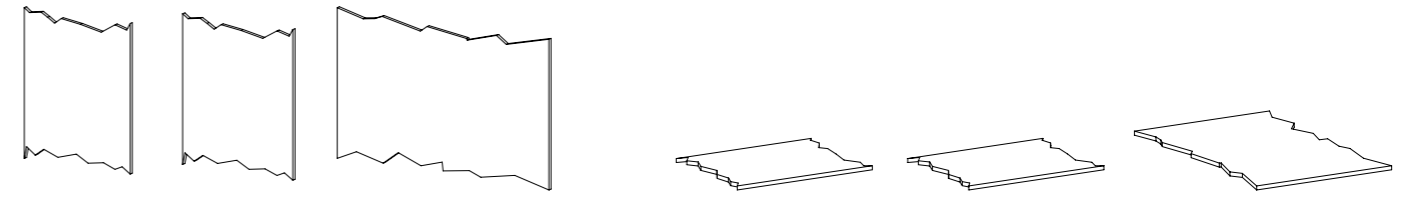

Ordered per metre		Thickness (mm)	Depth (mm)	Art. no.
Cover panel, module against wall	Used for mounting against a wall.	16	470/570	F4501-/F4502-
Cover panel, stand-alone module	Used for a stand-alone module with an extra back.	16	490/590	F4503-/F4504-
Cover panel, module back to back	Used for stand-alone modules mounted back to back.	16	940/1040/1140	F4505-/F4506-/F4507-
Capping panel, module against wall	Used for mounting against a wall.	16	470/570	F4508-/F4509-
Capping panel, stand-alone module	Used for a stand-alone module with an extra back.	16	490/590	F4510-/F4511-
Capping panel, module back to back	Used for stand-alone modules mounted back to back.	16	940/1040/1140	F4512-/F4513-/F4514-

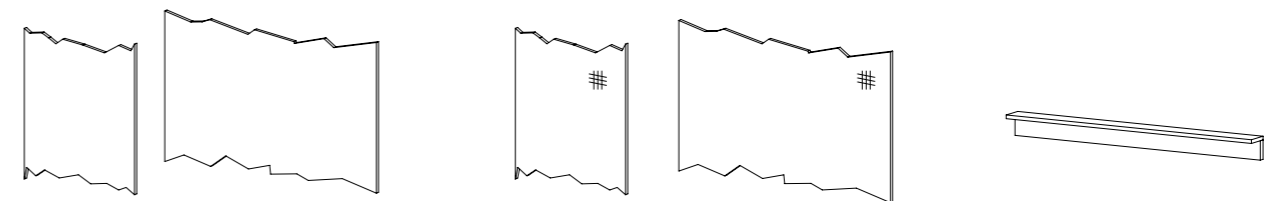

Ordered per metre		Thickness (mm)	Depth (mm)	Art. no.
Extra back		16	800	F4515-
		16	1200	F4516-
Extra back textile	Finns även som Bulletinboard	16		
		16		
Skirting board and trim incl. adjustable feet	Height 100, Thickness 16 mm. Ordered per metre. Maximum length of seamless skirting board 2400 mm. In the case of a stand-alone module, a skirting board is needed on both sides.	Height (mm)		
		100		F4520-
		200		F4521-





FLEX ACCESSORIES

Doors are available in several designs. In addition to different types of locks, you can also add letterboxes, different handles and numbering. We have a handle that is designed uniquely for the Flex system, this is available both with and without numbering.

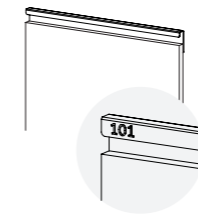

FLEX DOOR
HANDLE 1

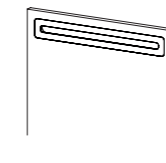

FLEX DOOR
LETTERBOX

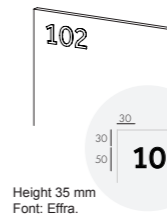

FLEX DOOR
NUMBERING

Height 35 mm
Font: Elfra,
Special orders are possible.

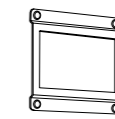

BUSINESS CARD HOLDER
/NAME PLATE

FLEX DOOR - HANDLE 1
FLEX DOOR - LETTERBOX
FLEX DOOR - NUMBERING
BUSINESS CARD HOLDER/NAME PLATE

Standard is white powder coat
Standard is white powder coat
Cut-out decal in vinyl plastic
Standard is white powder coat

Numbering is possible

Art. no.
F7501-
F7601-
F7602-
F7603-

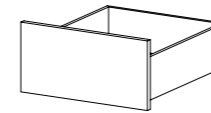

DRAWER 200

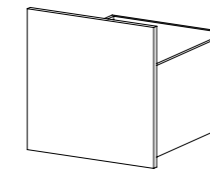

DRAWER 400

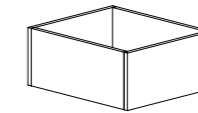

PLANTING BOX 400

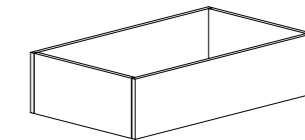

PLANTING BOX 800

	Width (mm)	Height (mm)	Depth (mm)	Art. no.
DRAWER 200	397	197	400	F7604-
DRAWER 200	397	197	500	F7605-
DRAWER 400	397	397	400	F7606-
DRAWER 400	397	397	500	F7607-

	Length (mm)	Length (mm)	Depth (mm)	Art. no.
PLANTING BOX 400	200	400	470	F7801-
PLANTING BOX 400	200	400	490	F7802-
PLANTING BOX 400	200	400	570	F7803-
PLANTING BOX 400	200	400	590	F7804-
PLANTING BOX 800	200	800	470	F7805-
PLANTING BOX 800	200	800	490	F7806-
PLANTING BOX 800	200	800	570	F7807-
PLANTING BOX 800	200	800	590	F7808-



DISPLAY CONTAINER
Ø 350

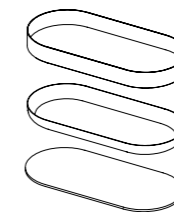

DISPLAY CONTAINER

		Width (mm)	Depth (mm)	Art. no.
DISPLAY CONTAINER	Display container Plastic insert	Ø 350	Ø 350	F7701-
DISPLAY CONTAINER	Wooden bottom Display container Plastic insert Wooden bottom	750	350	F7704-

FLEX LOCKS

FLEX is available with several different locking options. Below we list the most common options. Please contact us and we will help you find the best locking solution for your needs!

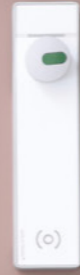

LOCK



PADLOCK

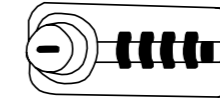

COMBINATION LOCK
-MANUALLY



ELECTRONIC LOCK

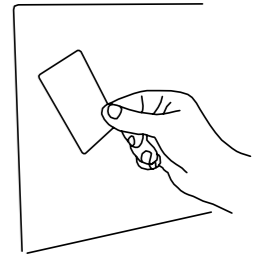

RFID-LOCK

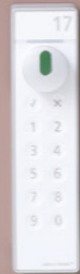

LOCK

Incl. 2 keys
Addition for identical locking
Main key

Art. no.
10 90 032 99
10 90 033 99
10 90 112 99

PADLOCK
COMBINATION LOCK
ELECTRONIC LOCK
RFID-LOCK

Excl. lock
Manually
Saga Access LS101
Flexlock Invisible 2.0 card, factory installed

098

G004

G005

G006

099

100



FLEX PROJECT TABLE

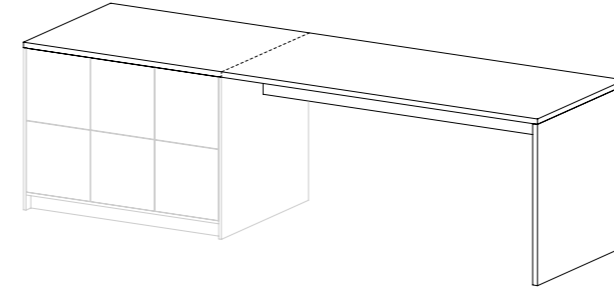

PROJECT TABLE LOW

A project table in this design provides a 930 mm high table with storage under the table top.

The project table is built with 800 mm high modules. The maximum length of the jointless table top is 2400 mm.

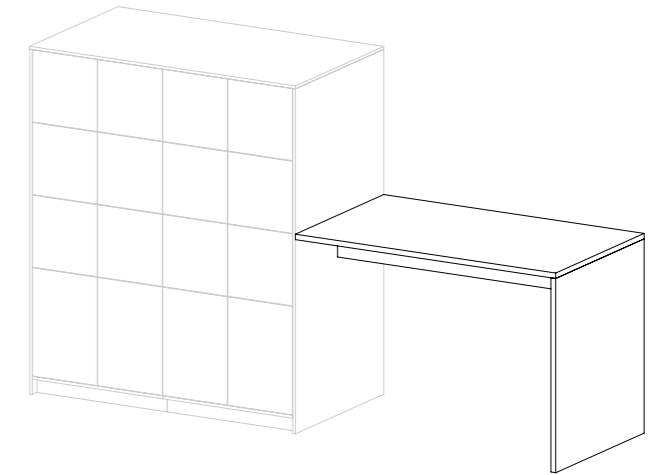

PROJECT TABLE HIGH

A project table in this design provides a 1100 mm high table with storage on the side of the table top.

The project table is built from modules with optional heights. The maximum length of the jointless table top is 2400 mm.

	Width (mm)	Height (mm)
PROJECT TABLE	940	930
PROJECT TABLE	1040	1100
PROJECT TABLE	1140	930
PROJECT TABLE	1140	1100

Length is adjusted according to the setup, maximum length of table top without joint is 2400 mm.
Longer project tables are manufactured with a single-sided top plate over modules.

For best durability, we recommend laminate for table surfaces.



FLEX SEATING MODULES

There are several different accessories that increase the areas of use and make FLEX more than just storage. Below are a number of components that enable meetings and work in combination with storage.

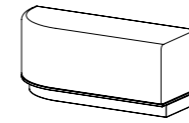

POUF 1-2

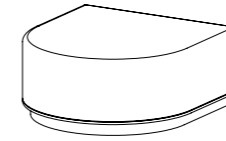

POUF 3-10

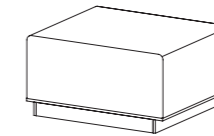

POUF 11-20

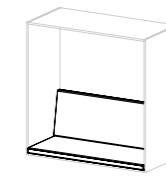

SOFA

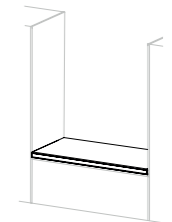

SEAT ON MODULE

		Height (mm)	Length (mm)	Depth (mm)	Art. no.
POUF 1-2	Against wall	500	1200	470	F7101-
POUF 3-10	Free standing	500	1200	570	F7102-
		500	1200	470-490*	F7103-
		500	1200	570-590*	F7104-
		500	1200	940	F7105-
		500	1200	1040	F7106-
		500	1200	1140	F7107-
		500	600	940	F7108-
		500	600	1040	F7109-
POUF 11-20	In between	500	600	1140	F7110-
		500	800	470-490*	F7111-
		500	800	570-590*	F7112-
		500	800	940	F7113-
		500	800	1040	F7114-
		500	800	1140	F7115-
		500	1200	470-490*	F7116-
		500	1200	570-590*	F7117-
*Depth varies depending on back option		500	1200	940	F7118-
		500	1200	1040	F7119-
		500	1200	1140	F7120-
SOFA	Added to open module 800x1200, 1200x1200	1200	800	470	F7201-
		1200	1200	470	F7202-
		1200	800	570	F7203-
		1200	1200	570	F7204-
SITS PÅ MODUL		55	800	470-490	F7161-
		55	800	570-590	F7162-
		55	1200	470-490	F7166-
		55	1200	570-590	F7167-

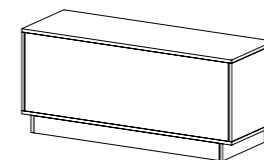

END TABLE



ADDITIONAL TABLE

	Height (mm)	Length (mm)	Depth (mm)	Art. no.	
END TABLE	500	490	400	F7001-	
	500	590	400	F7002-	
	500	940	400	F7003-	
	500	1040	400	F7004-	
	500	1140	400	F7005-	
ADDITIONAL TABLE	Table top	Height (mm)	Length (mm)	Width (mm)	Art. no.
	Metal base	650*	400	300	F8011 - F7802-

*Given measurements are from floor to top when the table is mounted on a pouf.



FLEX ACCESSORIES

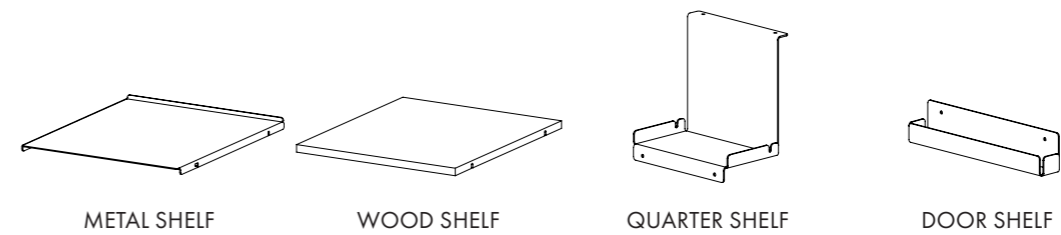

		Height (mm)	Width* (mm)	Depth (mm)	Art. n.
METAL SHELF	Movable White powdercoat is standard	376	376	438	F7403-
		376	384	536	F7404-
		384	384	438	F7405-
		384	368	536	F7406-
		368	368	438	F7411
		368	368	536	F7412
WOOD SHELF	Movable White laminate is standard	376	376	438	F7407-
		376	384	536	F7408-
		384	384	438	F7409-
		384	368	536	F7410-
		368	368	438	F7413
		368	368	536	F7414
QUARTER SHELF	White powdercoat is standard	215	120	210	F7401-
DOOR SHELF	White powdercoat is standard	60 (40**)	300	40	

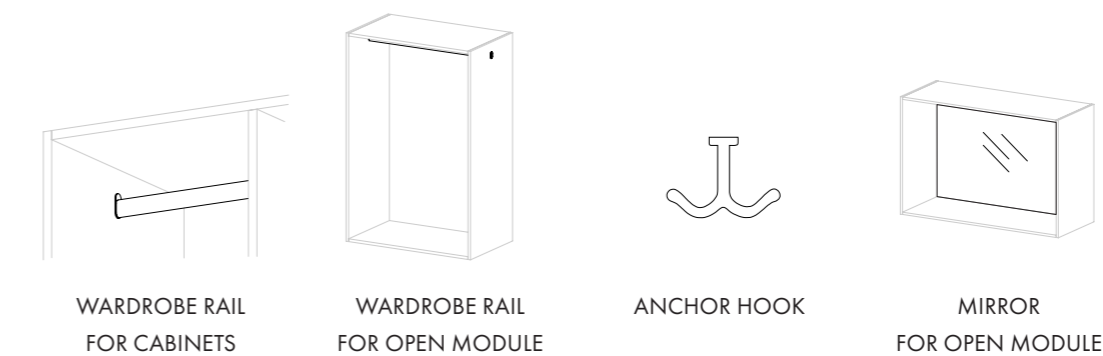

		Length (mm)	Width (mm)	Height (mm)	Art. no.
WARDROBE RAIL FOR CABINETS	Chrome powder coat	376	15	30	F8051-
WARDROBE RAIL FOR OPEN MODULE	Chrome powder coat	800	20	40	F8053-
		1200	20	40	F8054-
ANCHOR HOOK					F8052-
MIRROR FOR OPEN MODULE			400	400	F8004-
			800	400	F8005-
			800	800	F8006-
			1200	400	F8007-

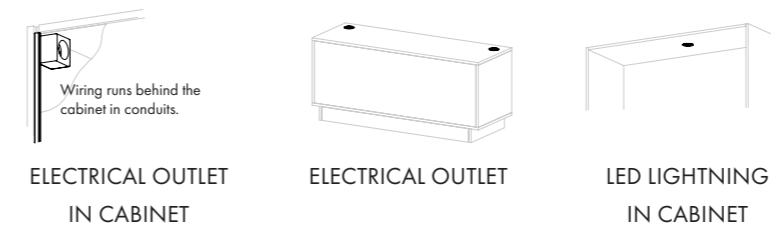

ELECTRICAL OUTLET IN CABINET					Art. no. F8011
ELECTRICAL OUTLET	Electrical outlet in end table, project table and open module		USB		F8021
			USB + Electrical outlet		F8031
			Electrical outlet		F8041
LED LIGHTNING IN CABINET 1PC.	Lighting fixture in stainless steel				





FLEX COLOURS & MATERIAL

The Flex system offers a range of standard colour and material choices.
Choose the one that best suits your project and contact us if you are missing something.

WET COATING

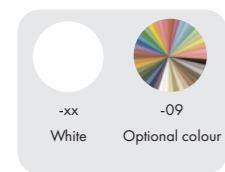

Wet coating in White	Art. no
Starting fee, any optional colour	Standard
Addition per coated unit	W0001
	W0002

POWDER COAT

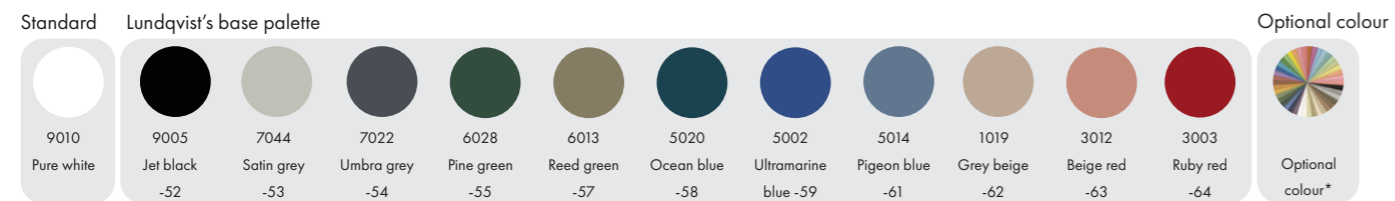

* Applies to RAL Classic-colors

Powder coating, Pure white 9010	Art. no
Starting fee, Lundqvist's base palette	Standard
Starting fee, any optional colour*	W0009
Addition per coated unit	W0008
	W0007

HIGH PRESSURE LAMINATE

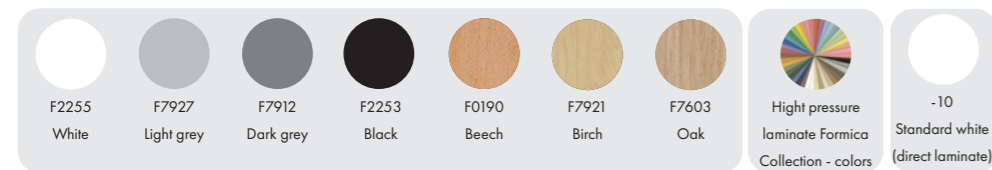

ABS-edging (1mm) in matching colour or edging (1mm) in matching wood.

Any high pressure laminate	Art. no
Formica Collection - colors	W0010

VENEER



Customized solutions are possible.
This may apply, for example, to other measures, surface material or colours.

Feel free to contact us and we will find the best solution for you!



“With FLEX we didn’t just want to make a personal storage that covered the needs that a personal storage requires.
We also wanted to find something that would make FLEX unique. By adding well-thought-out accessories to the storage system, it became an ensemble that also works for socializing and working.”

- Tim Alpen, Alpen Office

Alpen Office is a company that works in furniture design, product design and graphic design in various product areas, materials and techniques. Based on user-friendliness, construction solutions and a deeper understanding of production, we at Alpen Office want to deliver well-thought-out solutions in our projects.

GERMANY

Tel: +46 739 - 17 26 14

info@lundqvist.eu

order@lundqvist.eu

www.lundqvist.eu

f **@** [lundqvist_de](https://www.instagram.com/lundqvist_de)

SWEDEN

STOCKHOLM

Tel: +46 8 - 623 98 00

GOTHENBURG

Tel: +46 31 - 86 36 50

info@lundqvistinredningar.se

OTHER EXPORT

info@lundqvist.eu

Tel: +46 8 - 623 98 00

www.lundqvist.eu

LundqvistTM
INREDNINGAR